

BB-8 Droid - Star Wars

Fandom in Stitches Free Pattern

10" Paper Pieced excluding seam allowance

Now includes sizes 12, 15 & 20" paper pieced excluding seam allowance.

Designed by Vanda Chittenden

vanda@chittenden.co.za

www.chittenden.co.za

This pattern is not for sale, and finished products from this pattern can not be sold.
It is for non-profit and personal use only.

Please let me know of any mistakes on the pattern.

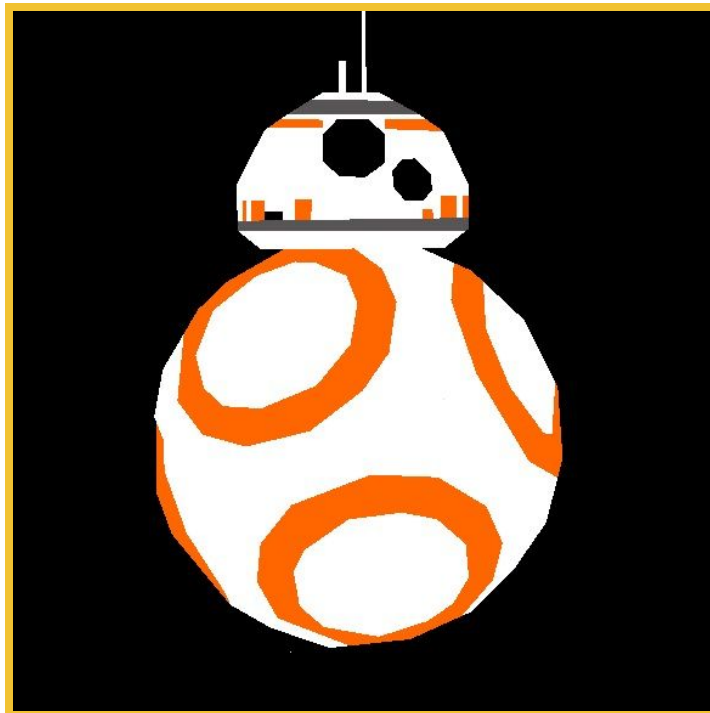

Sewing order

A+C

EF+G+H+I

BACD+OEFGHJKLMNP

B+AC+D

EFGHI+K+J+L+M+N

E+F

O+EFGHIJKLMN+P

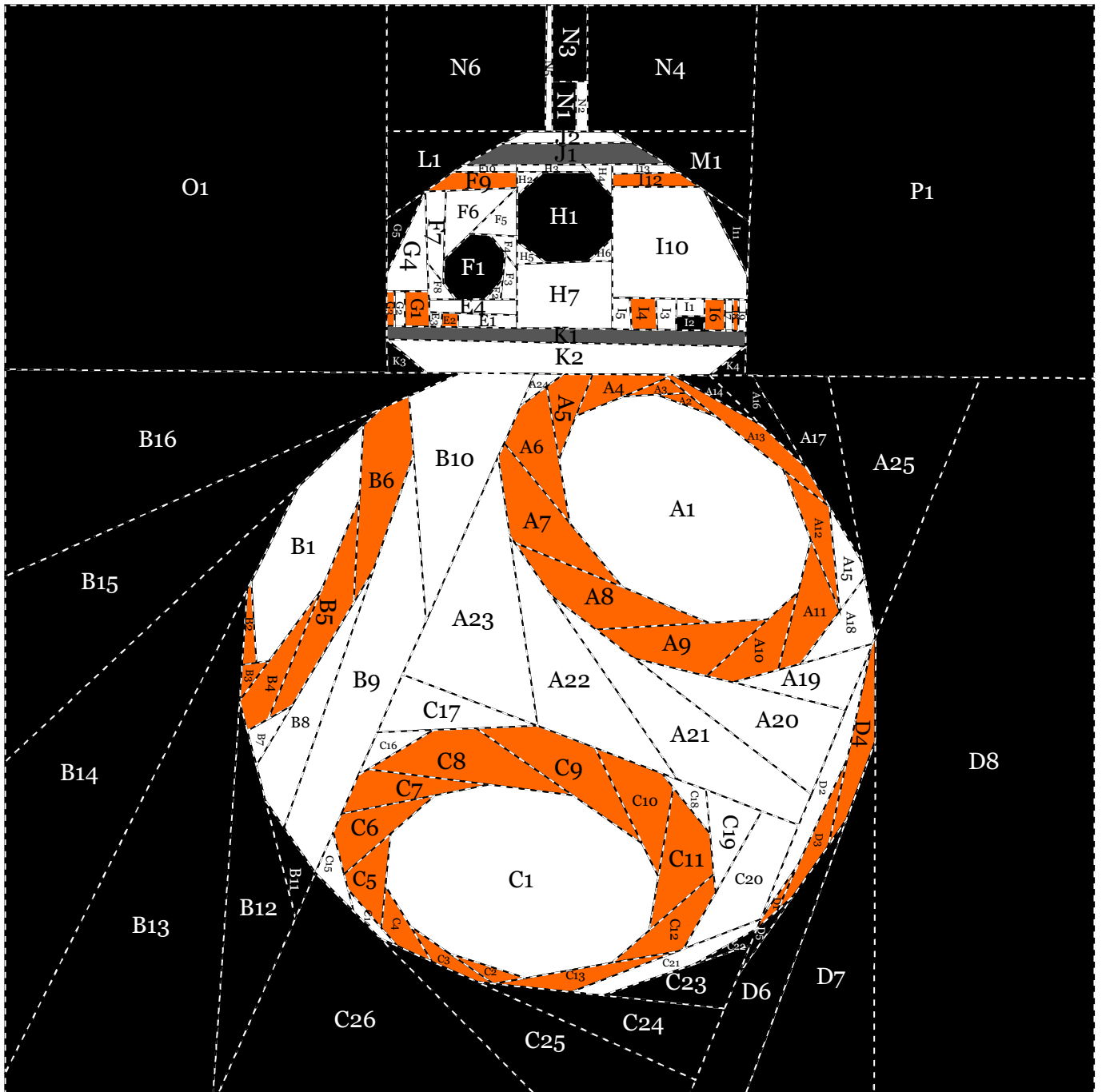

droid (at 71% of true size)

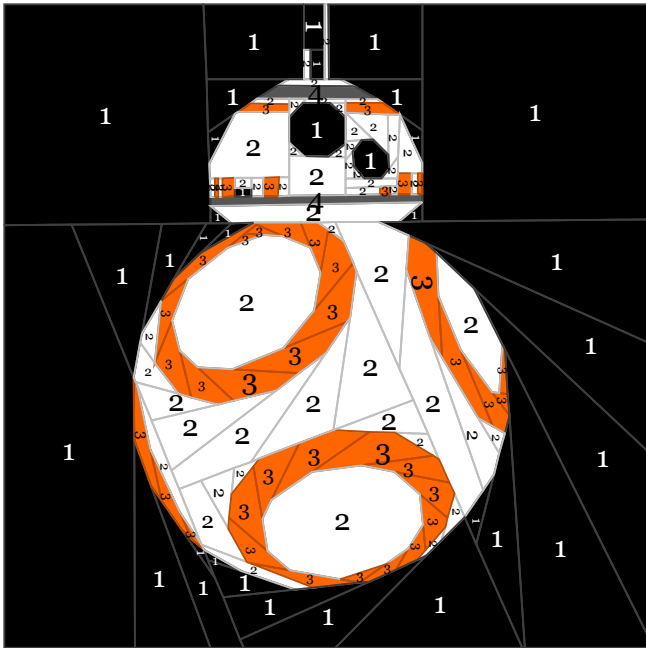

droid (at 34% of true size)



#1, used 34x, fabric 4-6 in

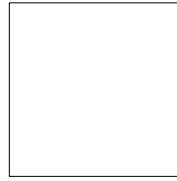

#2, used 54x, fabric 4 in

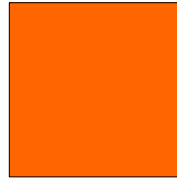

#3, used 40x, fabric 2 in



#4, used 2x, fabric 2 in

10" PATTERN

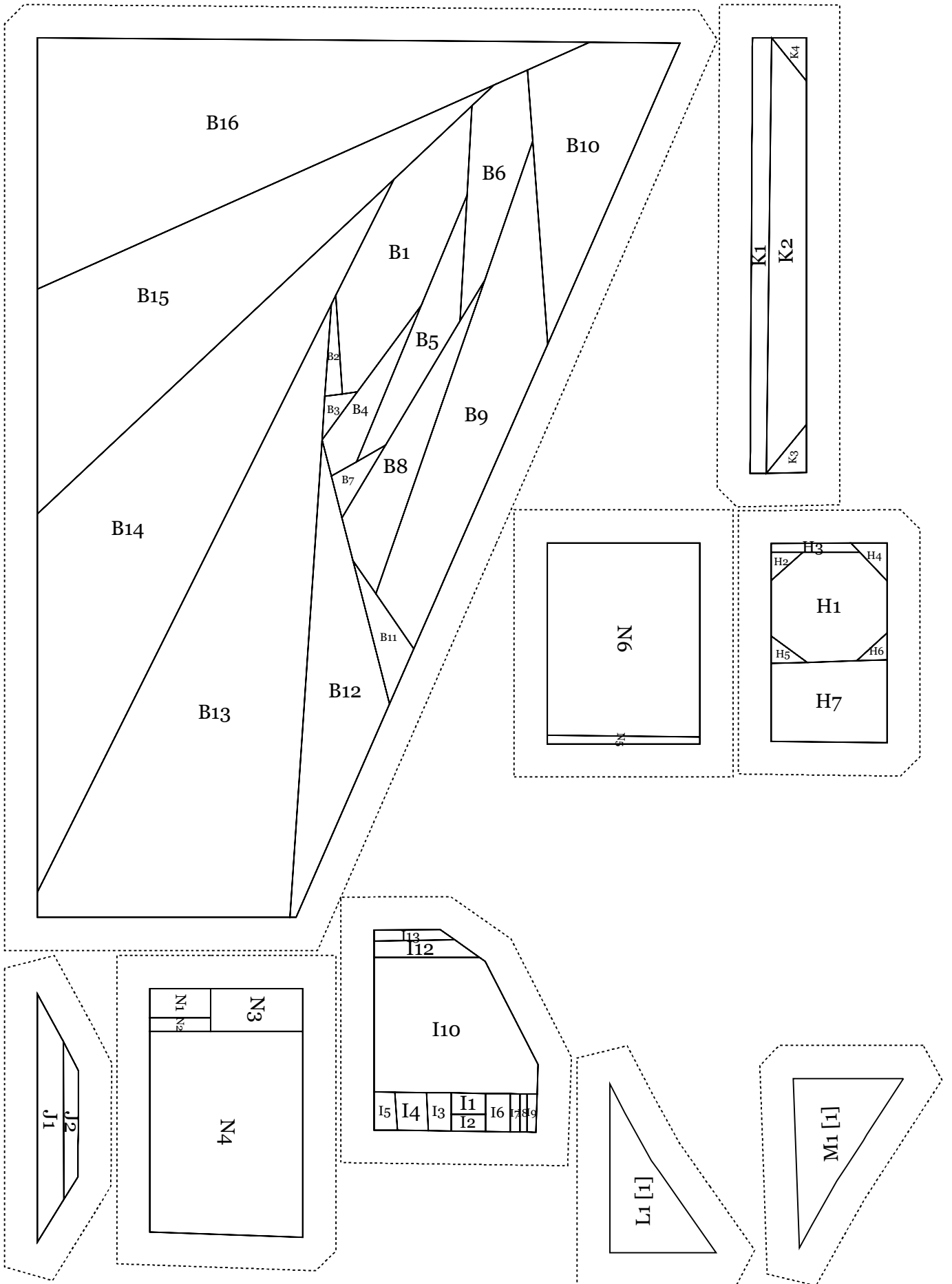

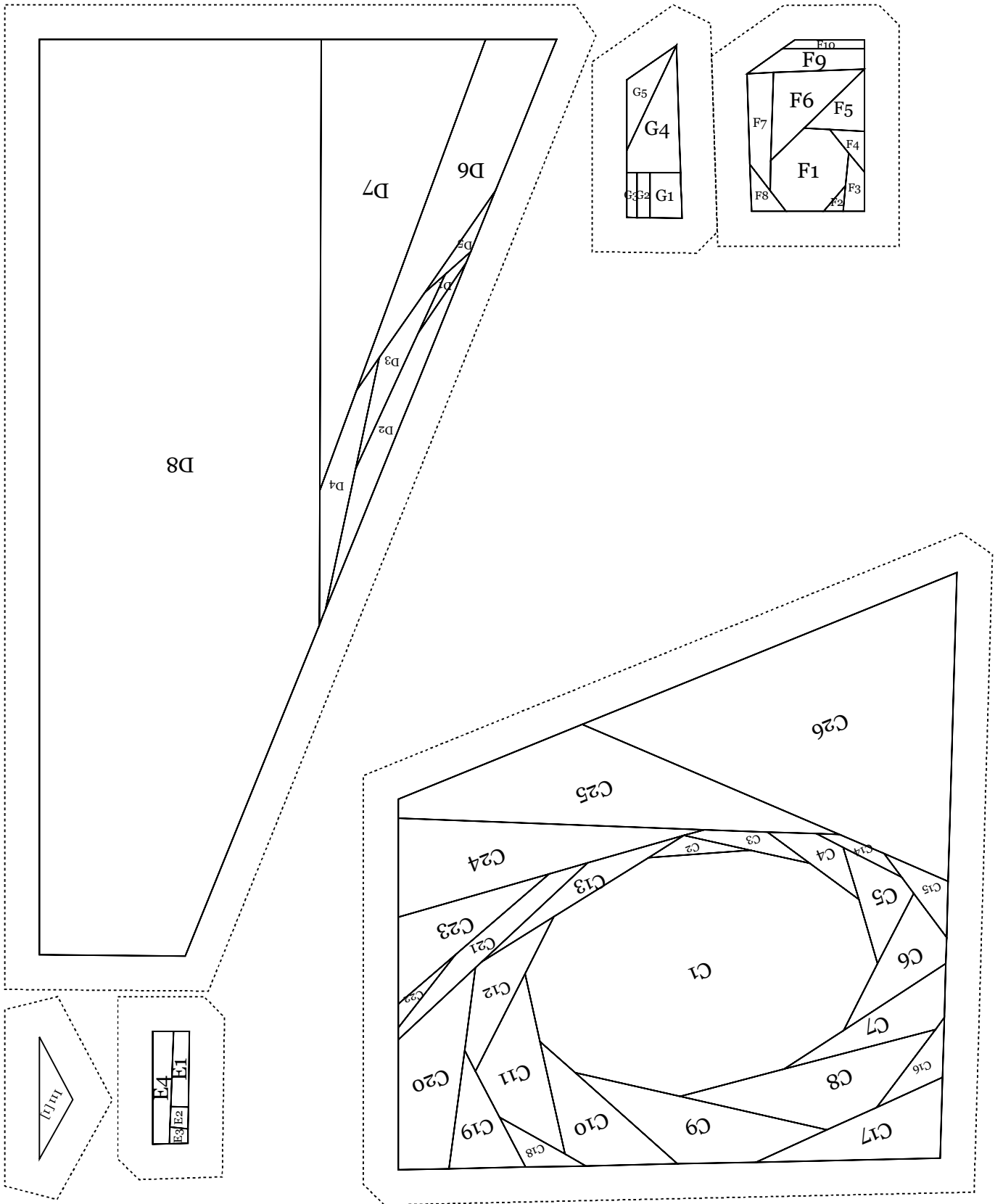

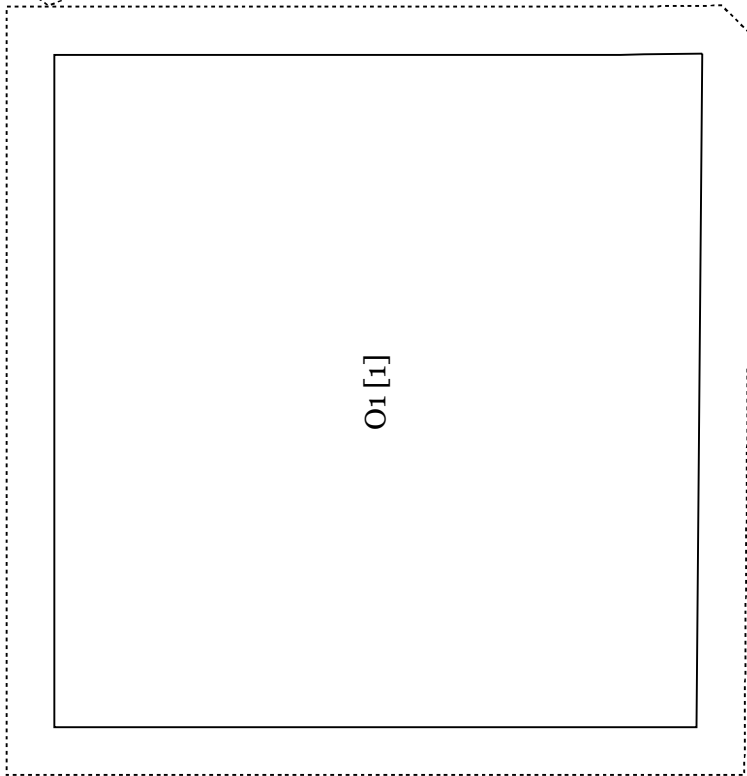
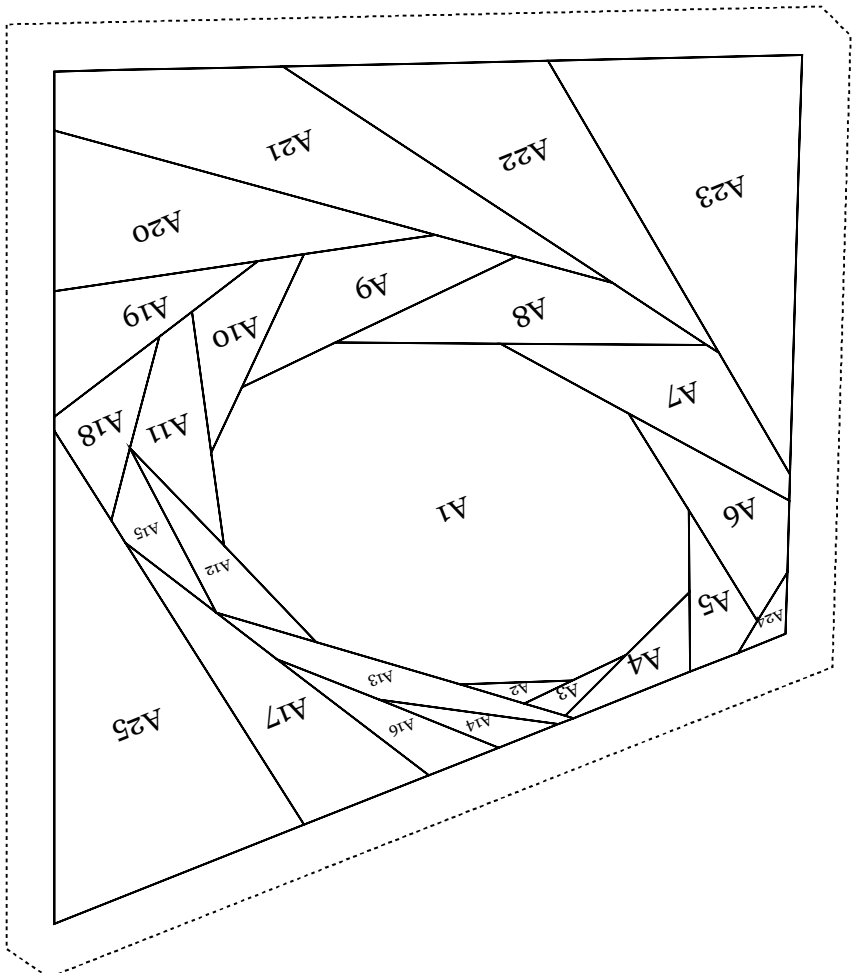



P1 [1]

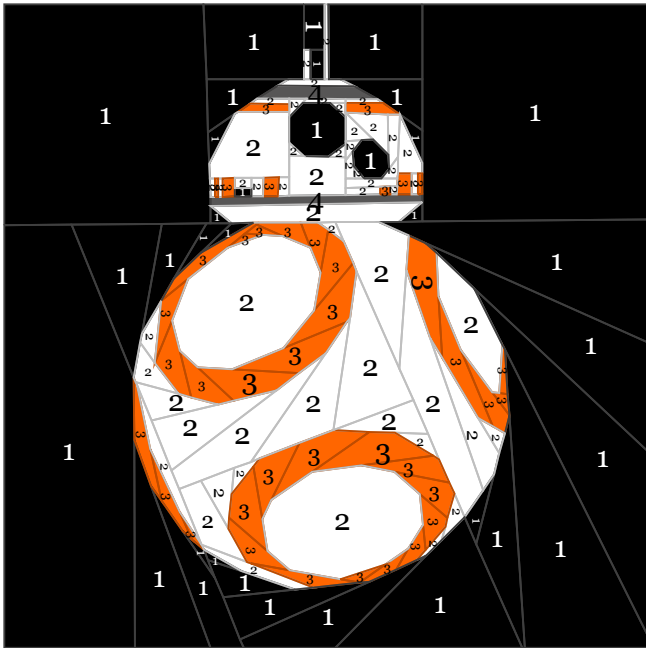

droid (at 28% of true size)



#1, used 34x, fabric 6 in

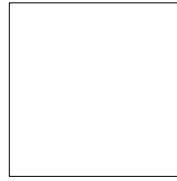

#2, used 54x, fabric 4 in

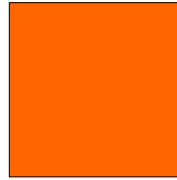

#3, used 40x, fabric 4 in

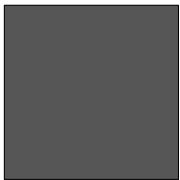

#4, used 2x, fabric 2 in

12" PATTERN

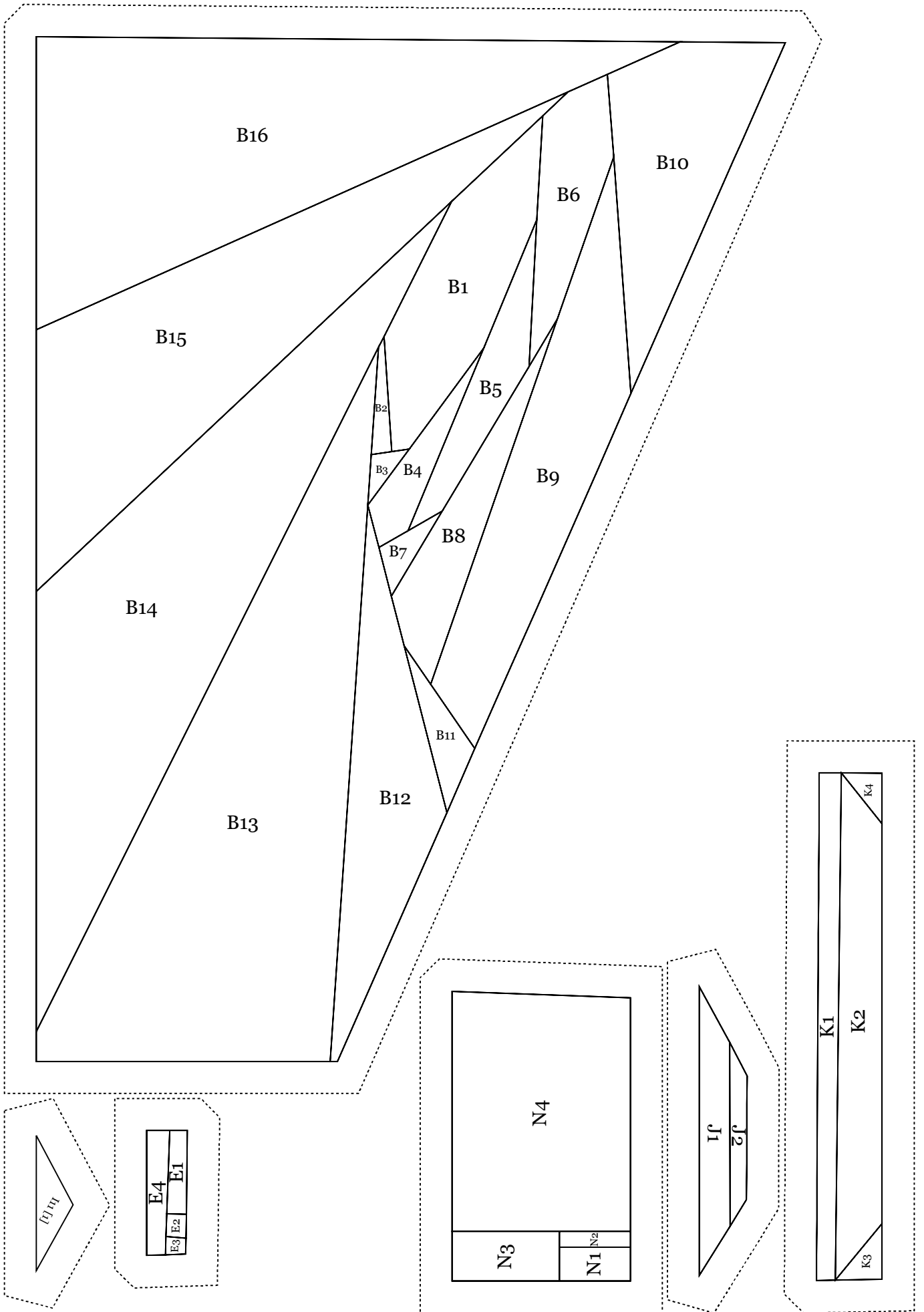

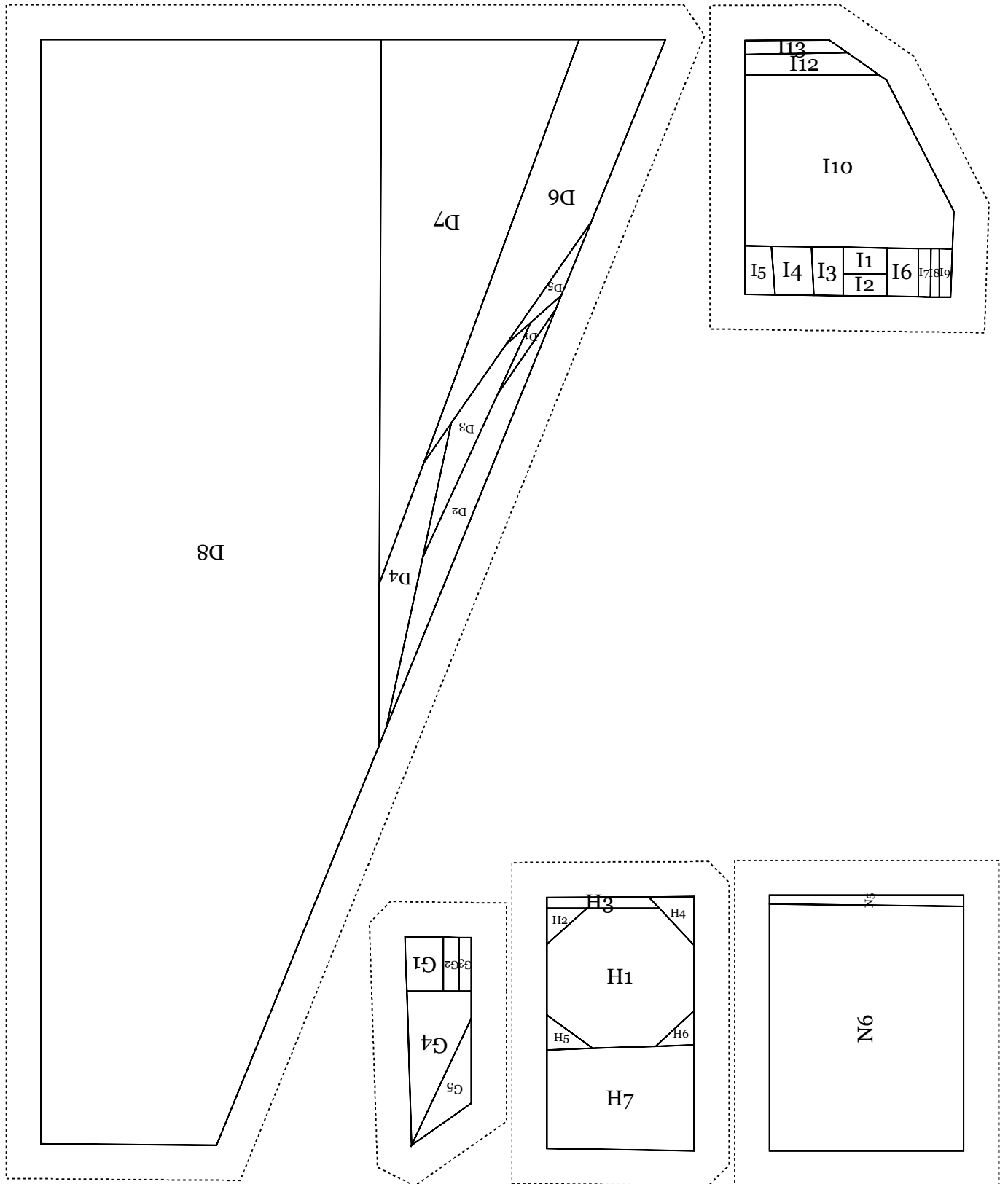

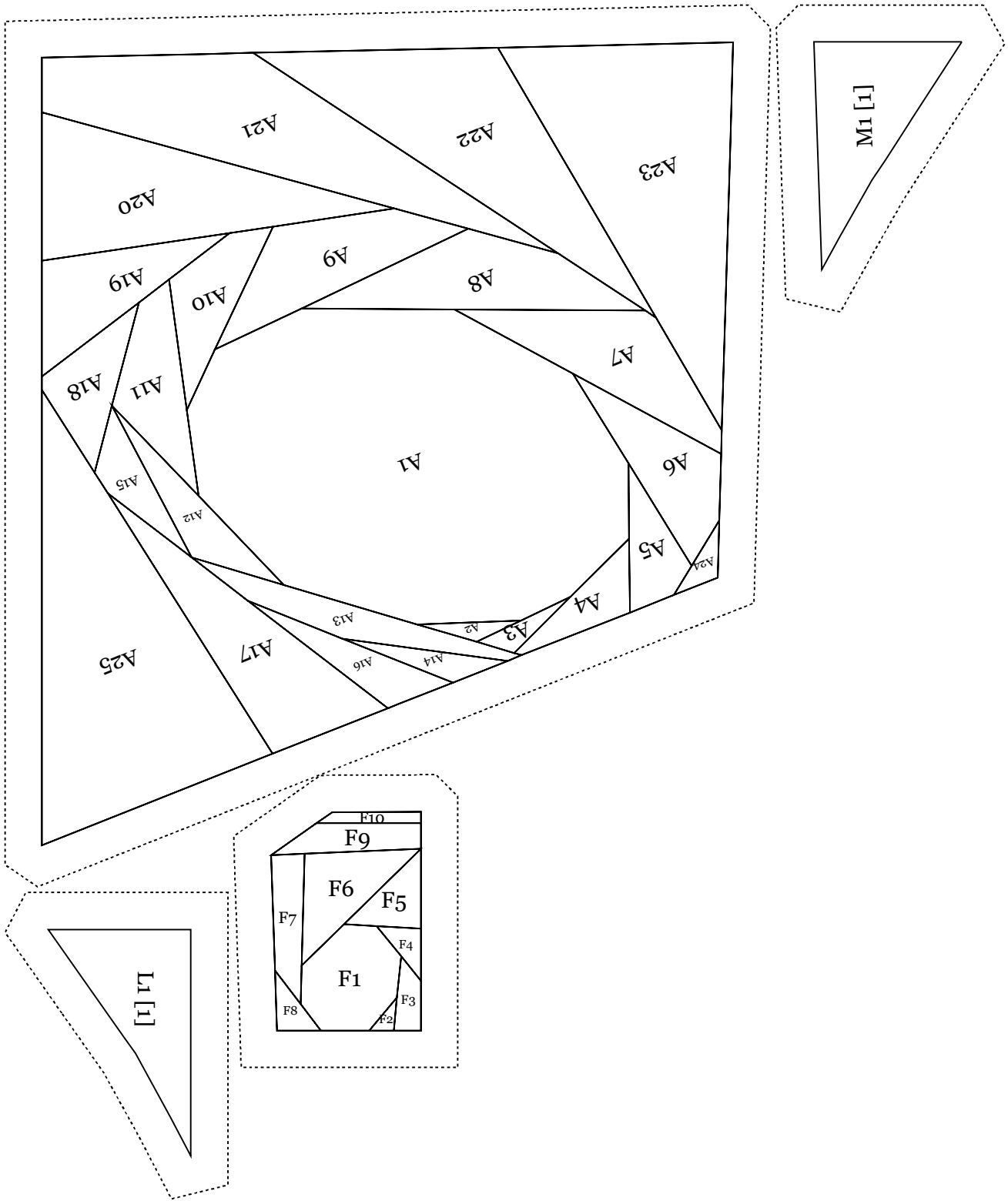

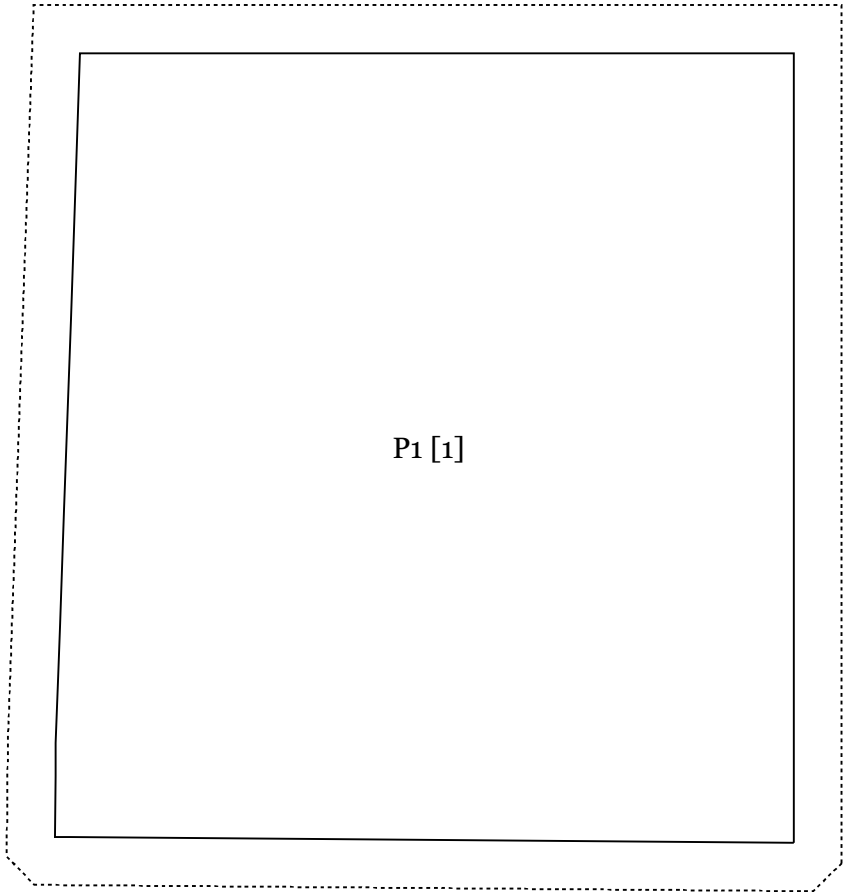
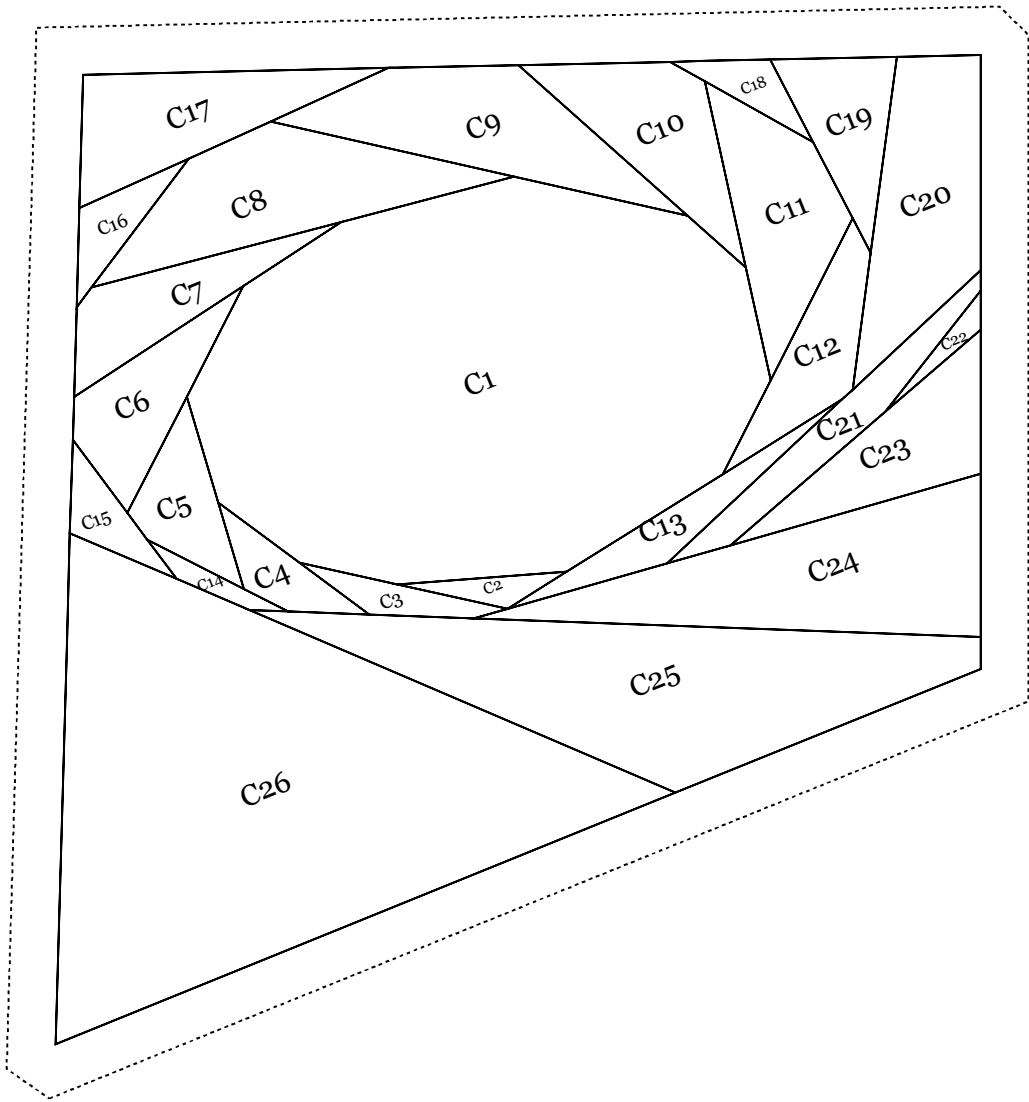

O1 [1]

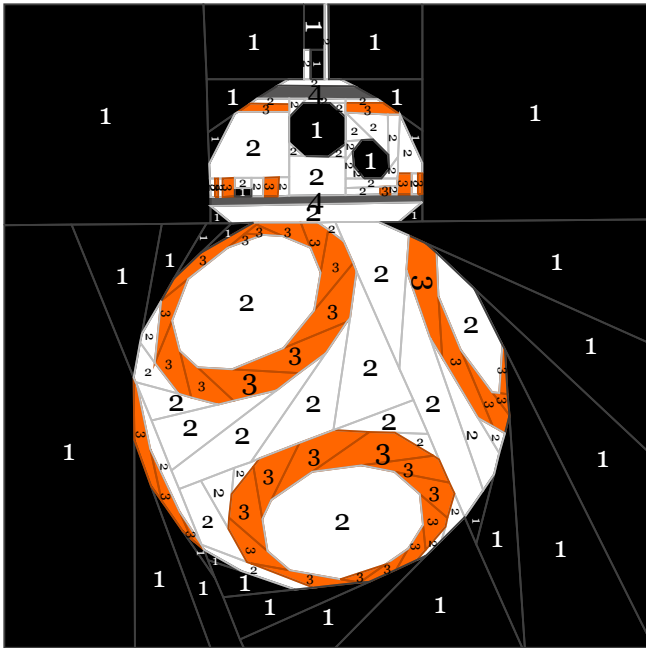

droid (at 22% of true size)



#1, used 34x, fabric 6-10 in

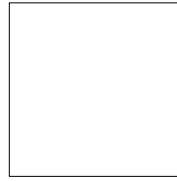

#2, used 54x, fabric 4-6 in

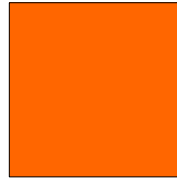

#3, used 40x, fabric 4 in

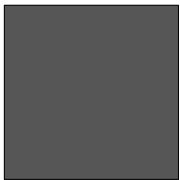

#4, used 2x, fabric 2 in

15" PATTERN

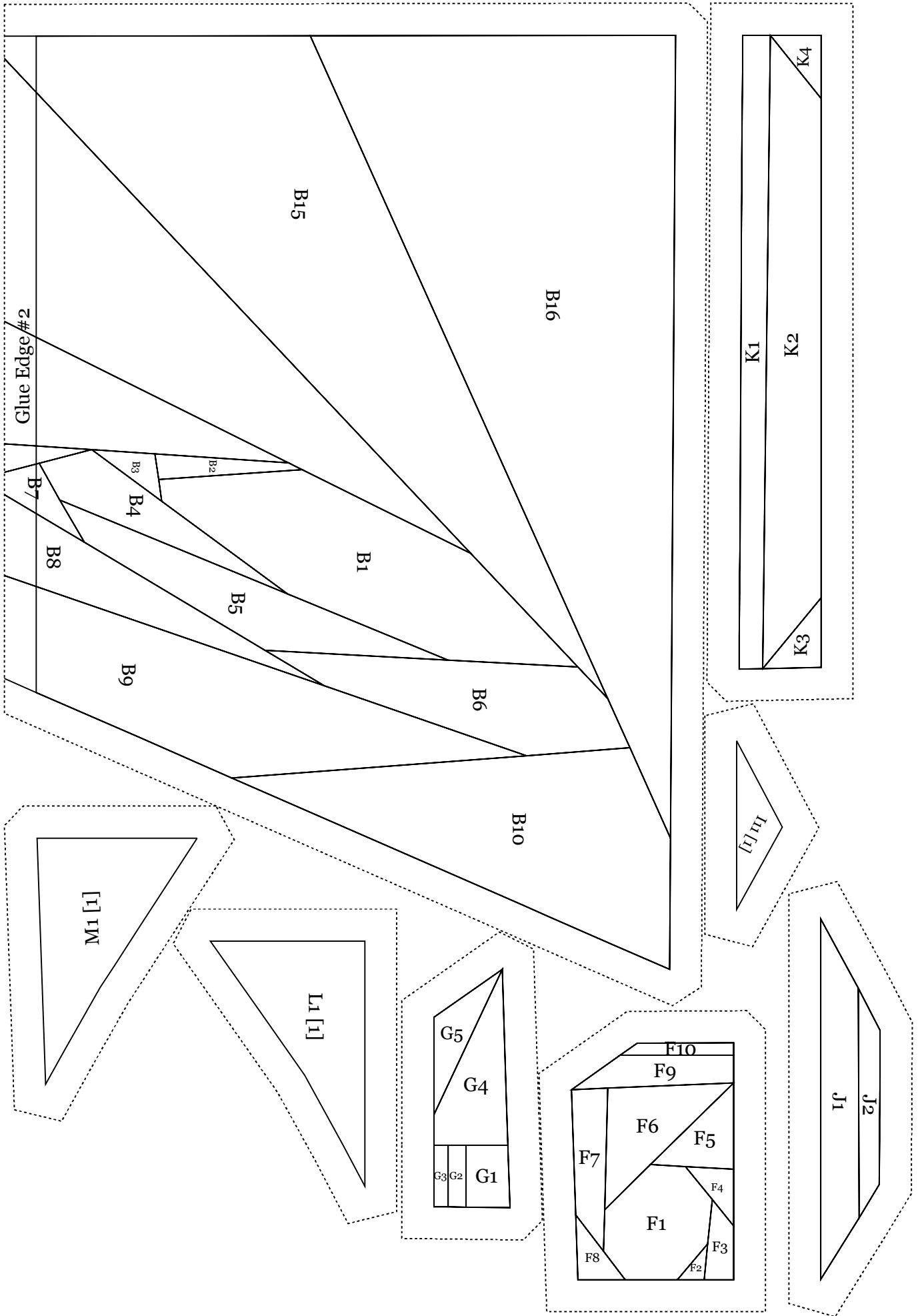

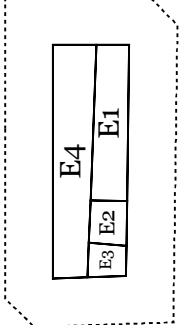
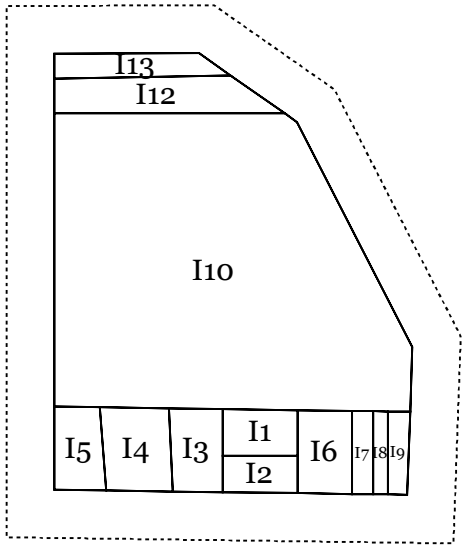
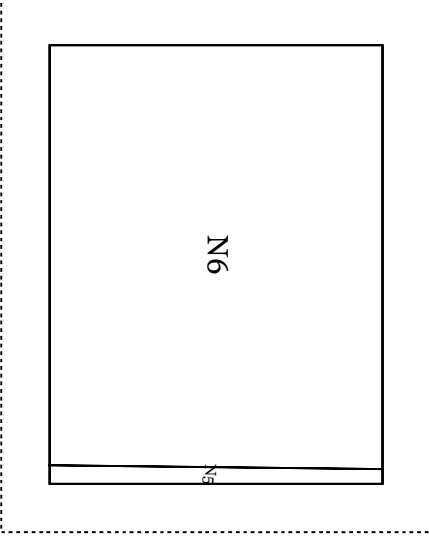
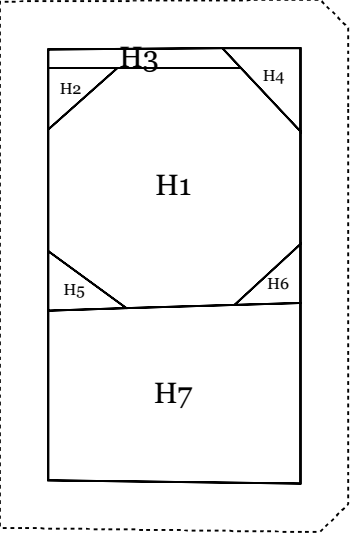
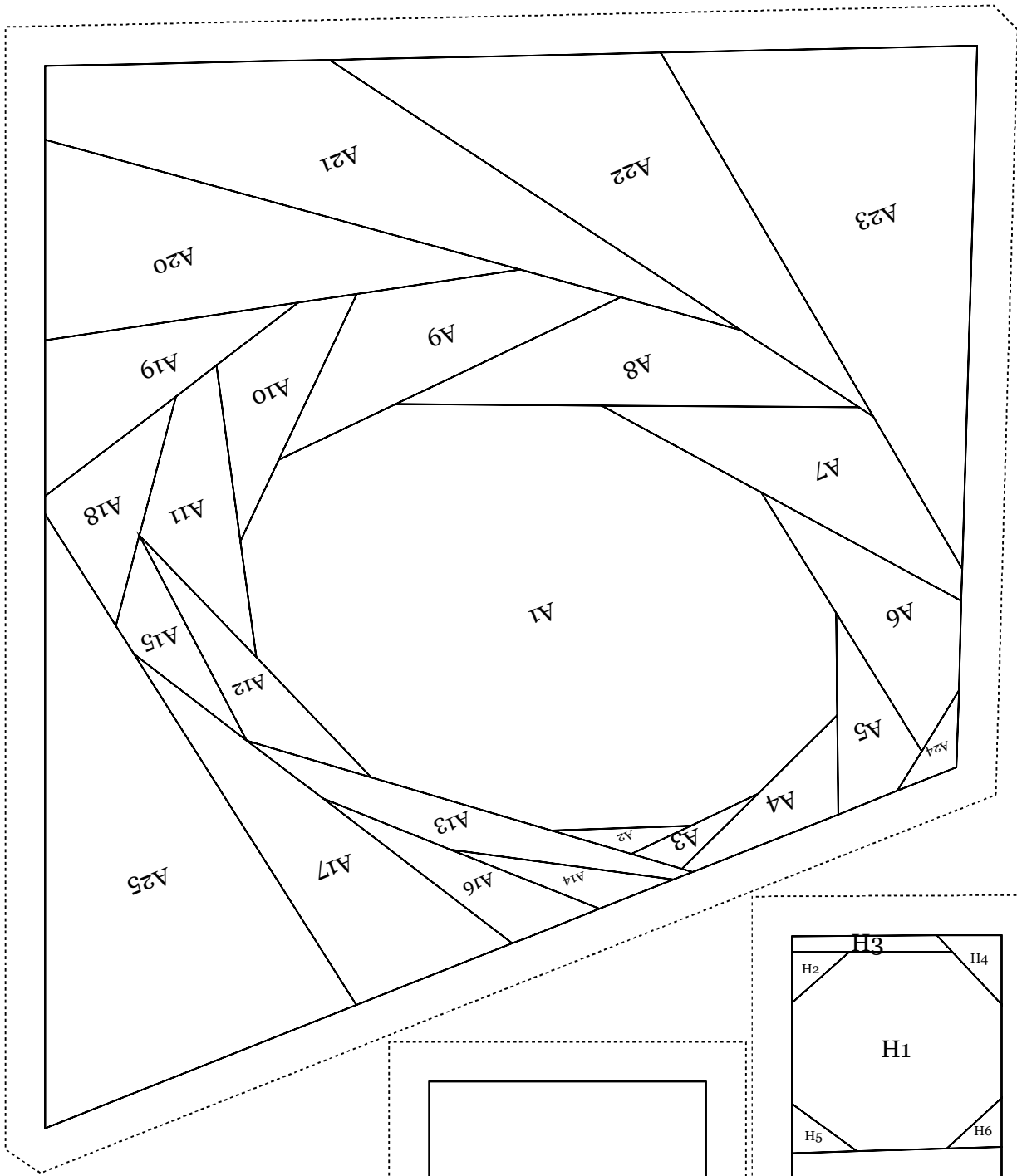

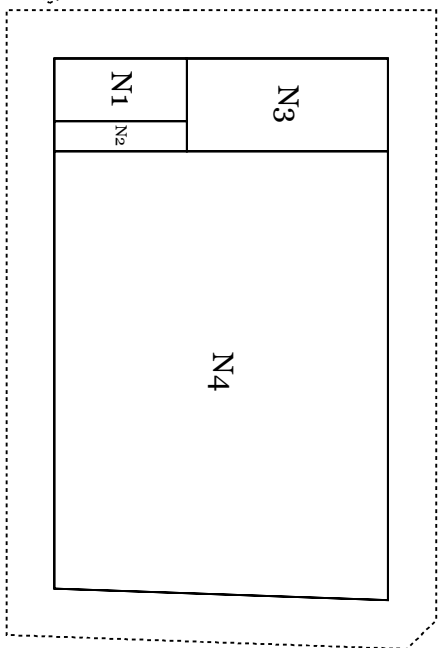
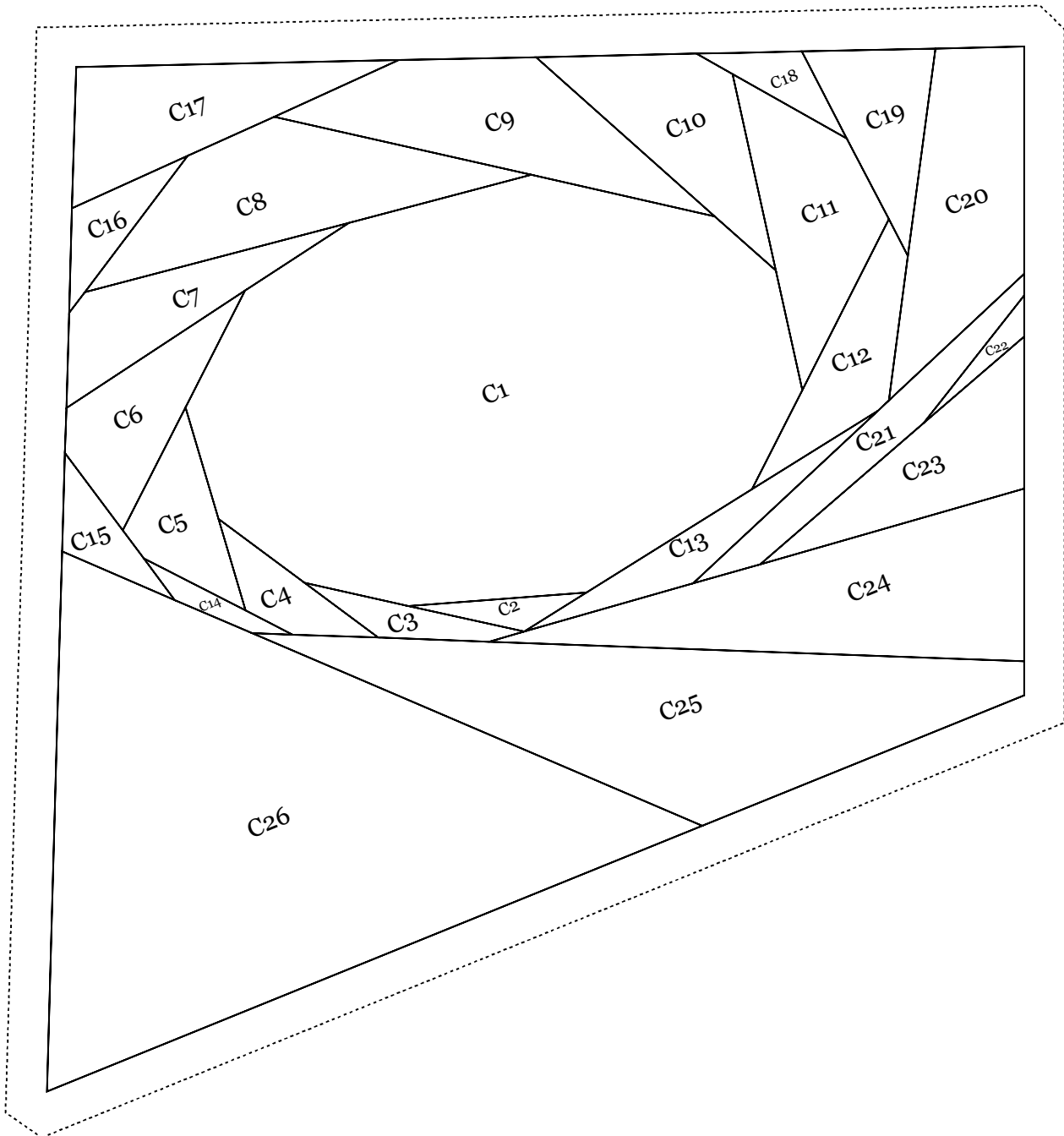

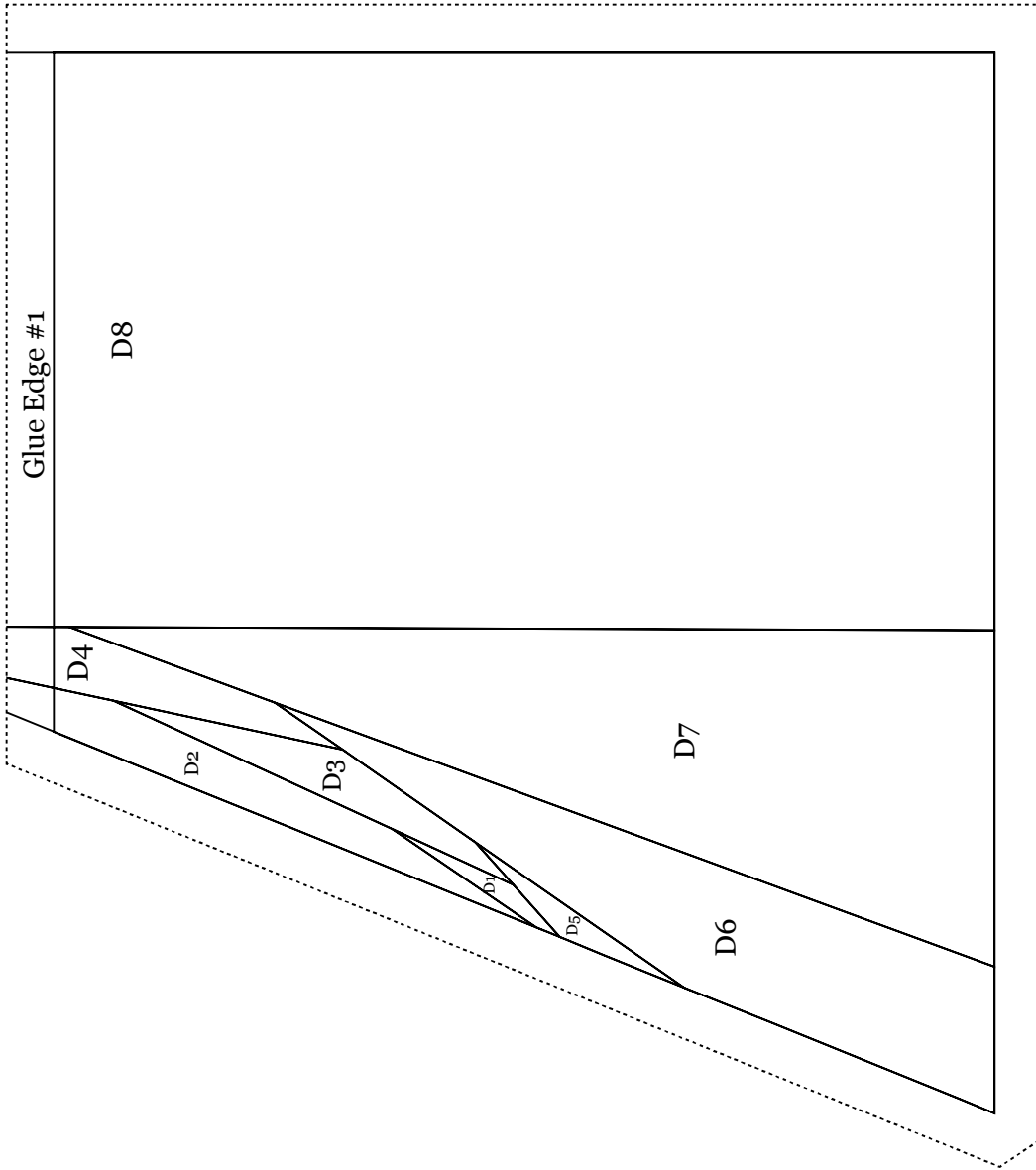

O1 [1]

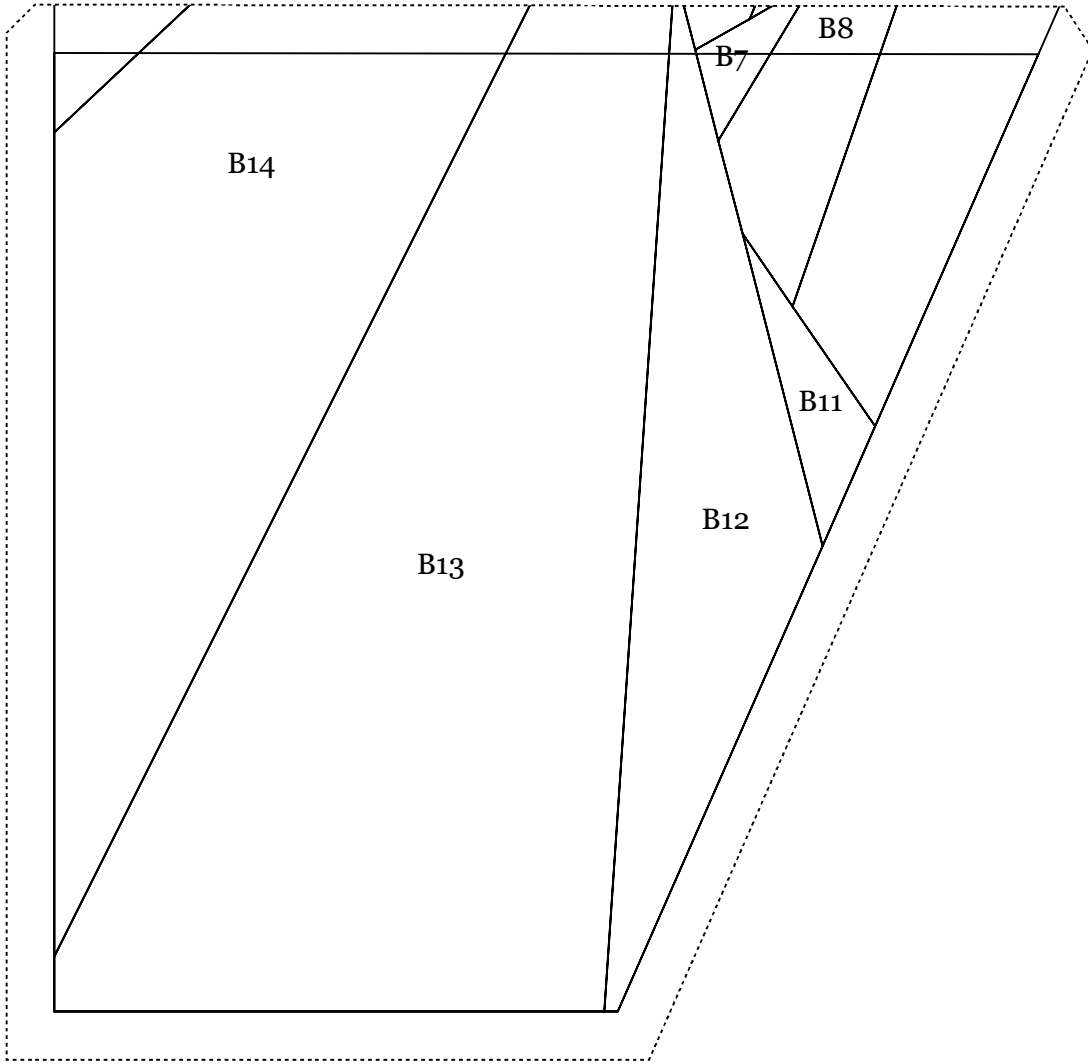

P1 [1]

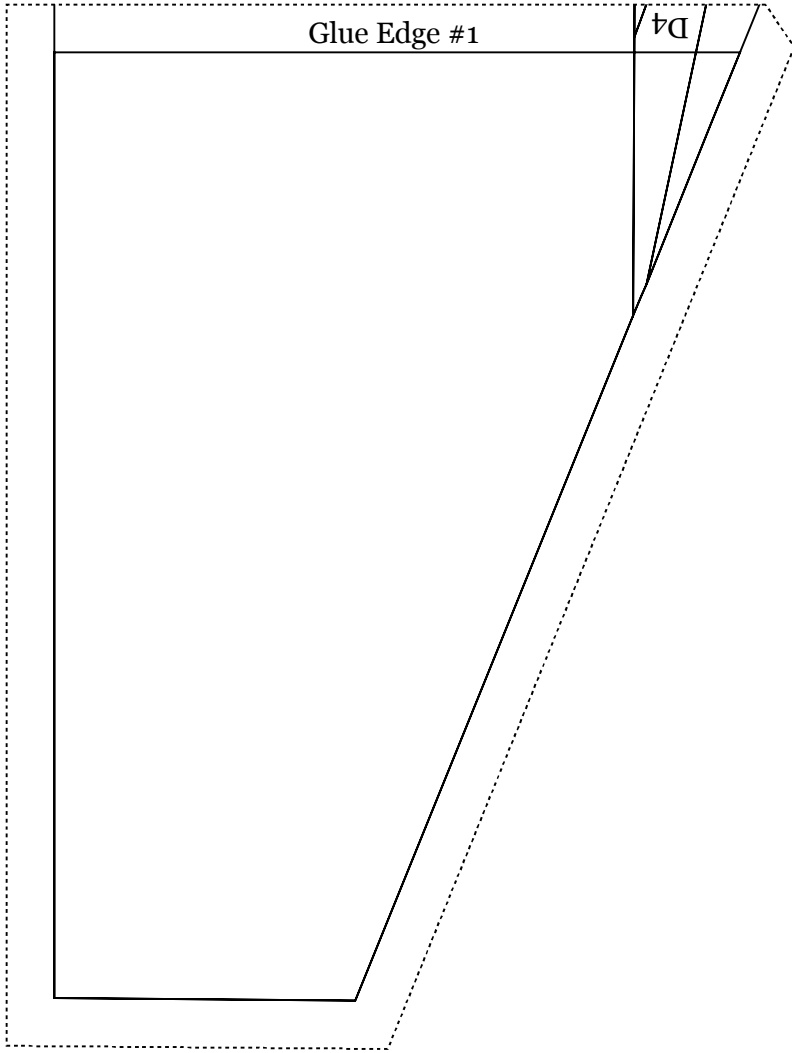

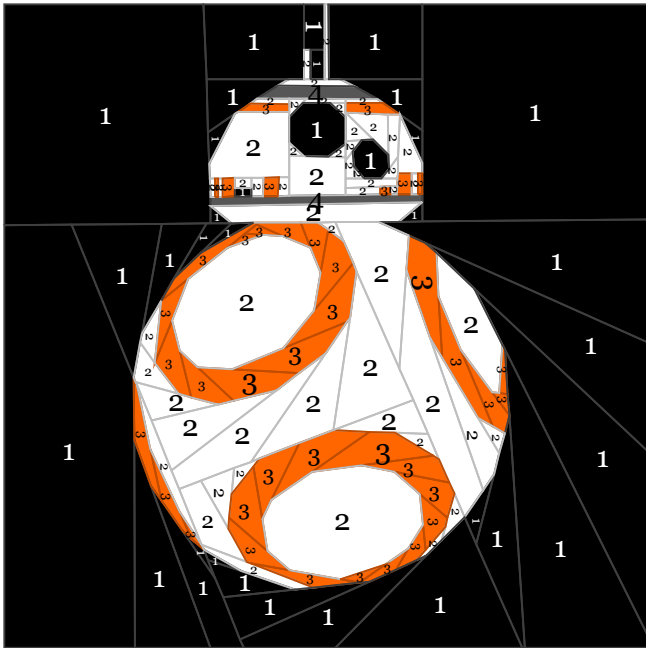

droid (at 17% of true size)



#1, used 34x, fabric 10-14 in

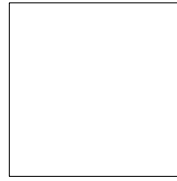

#2, used 54x, fabric 6-8 in

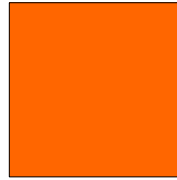

#3, used 40x, fabric 4 in

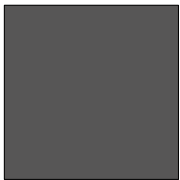

#4, used 2x, fabric 2 in

20" PATTERN

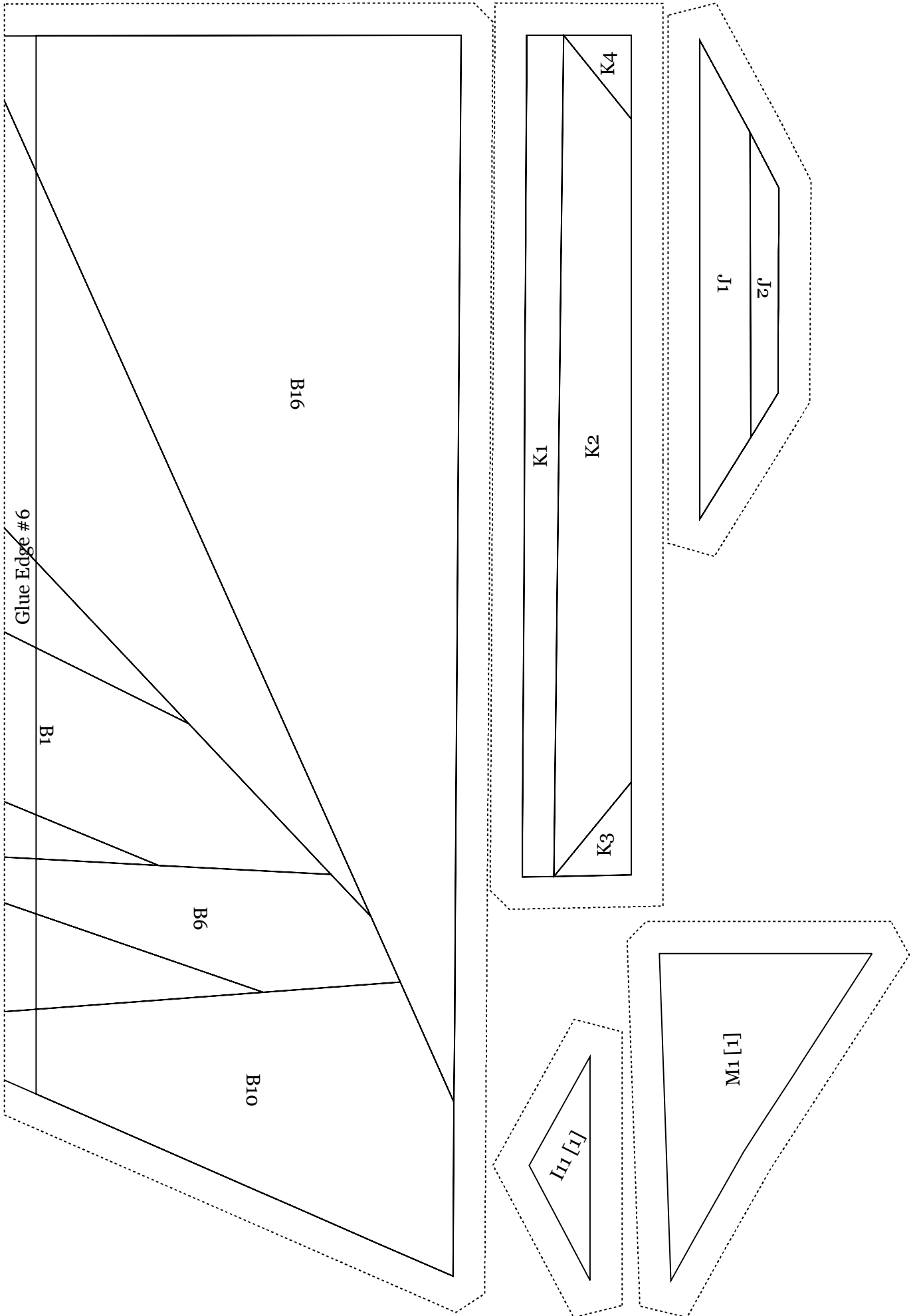

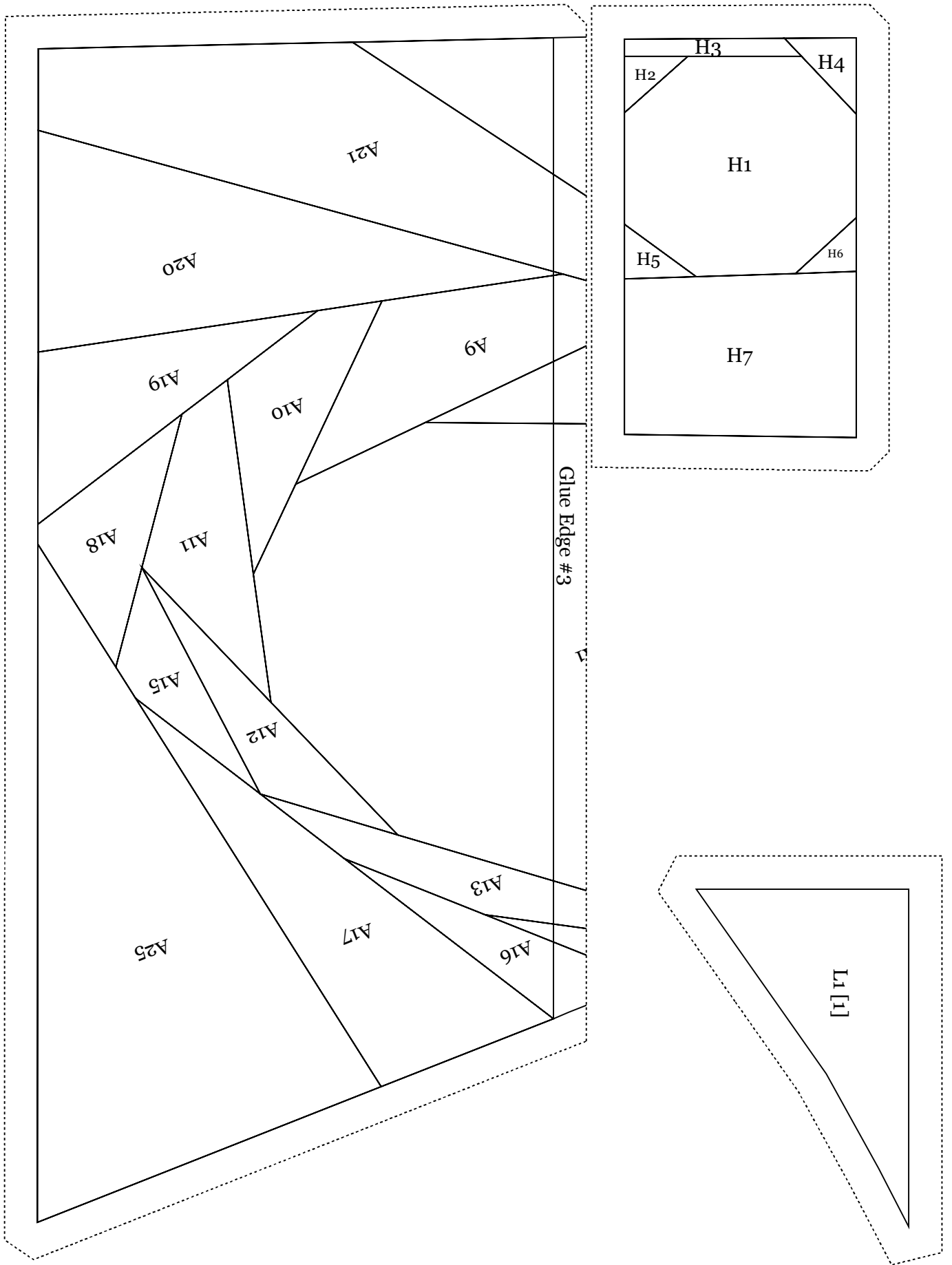

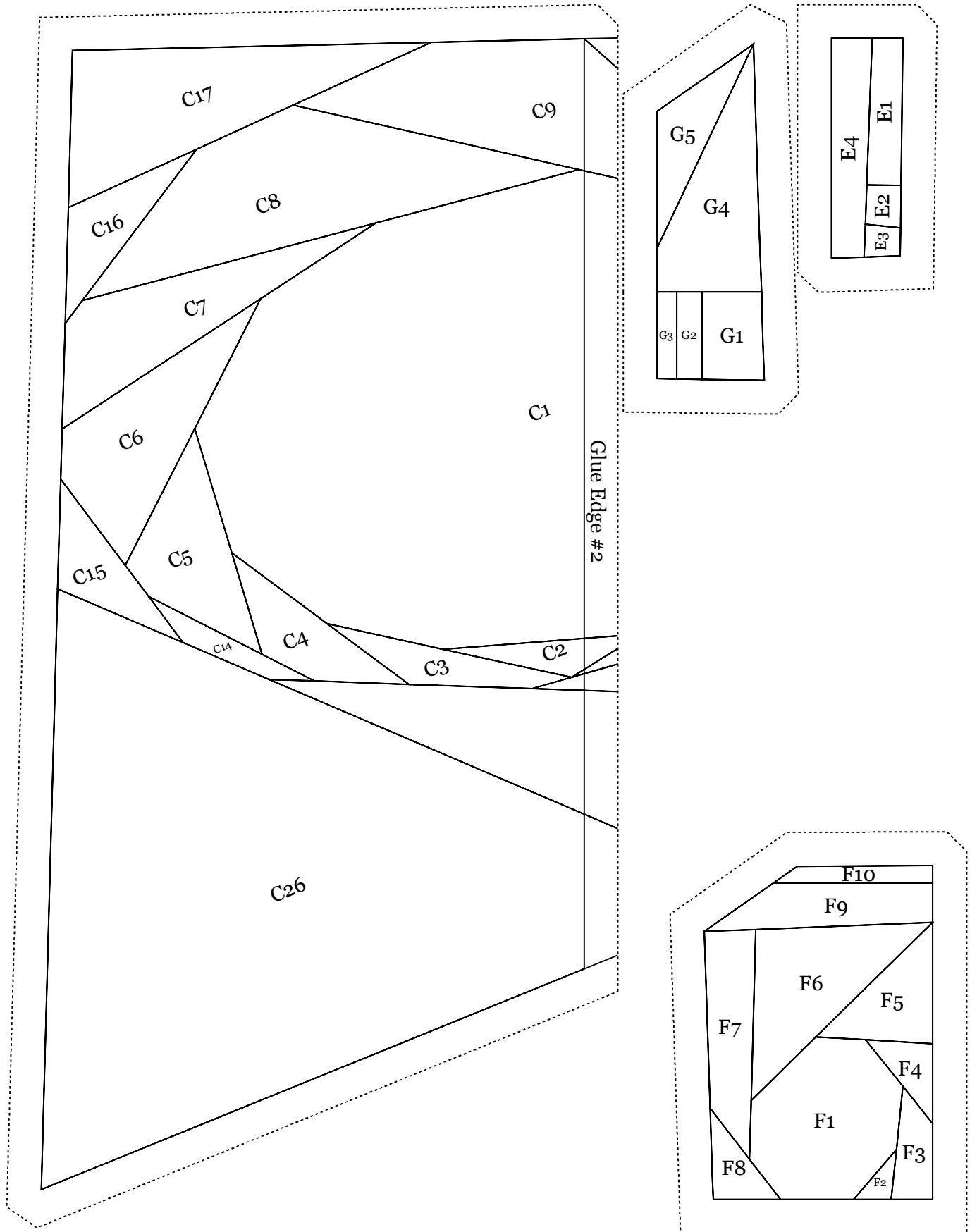

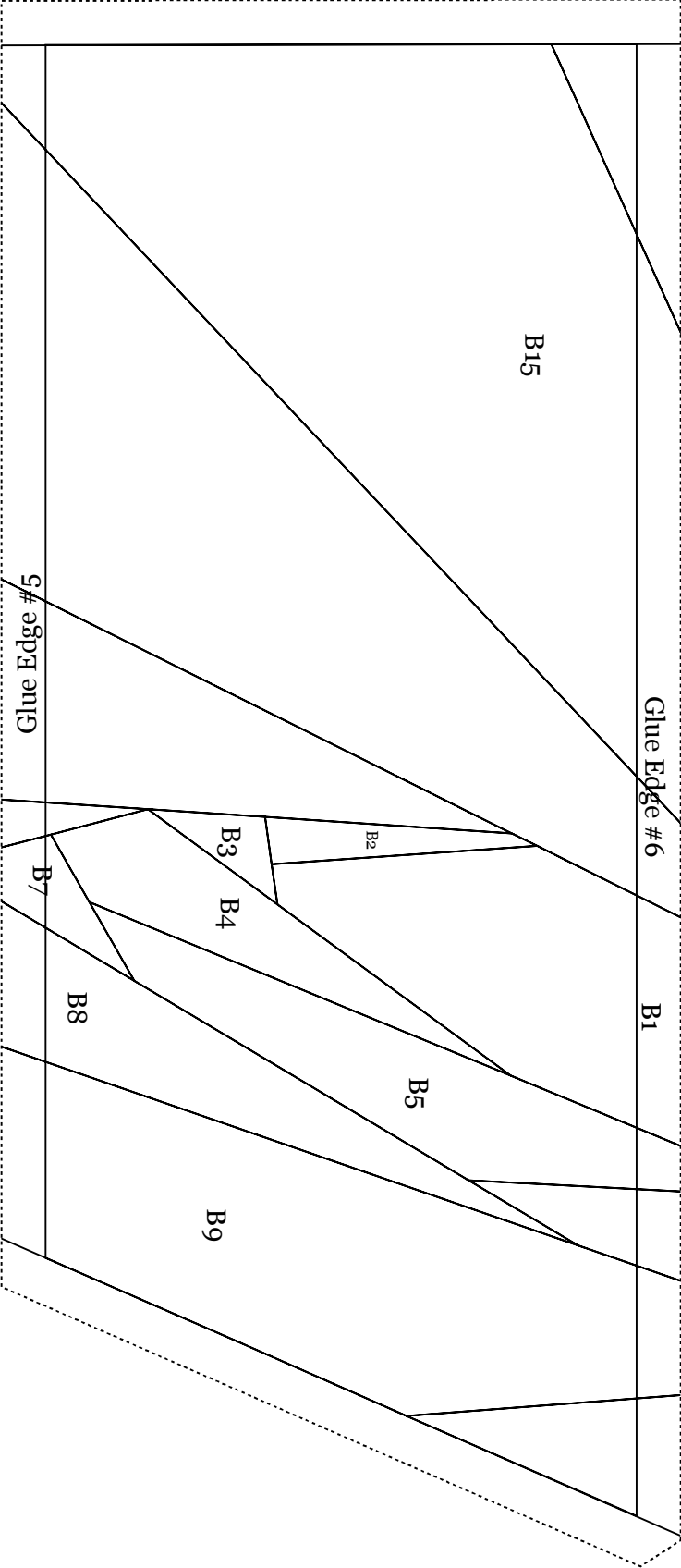
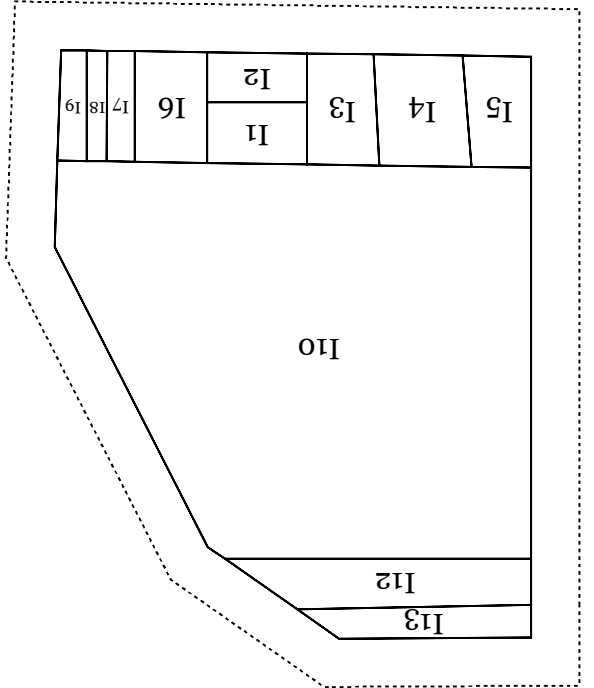
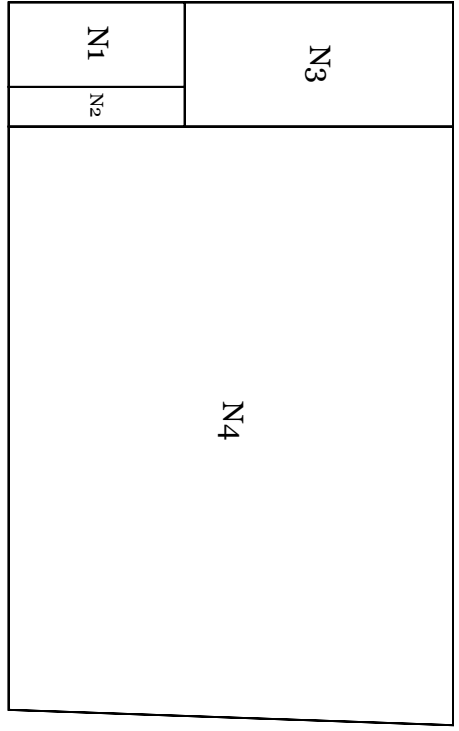

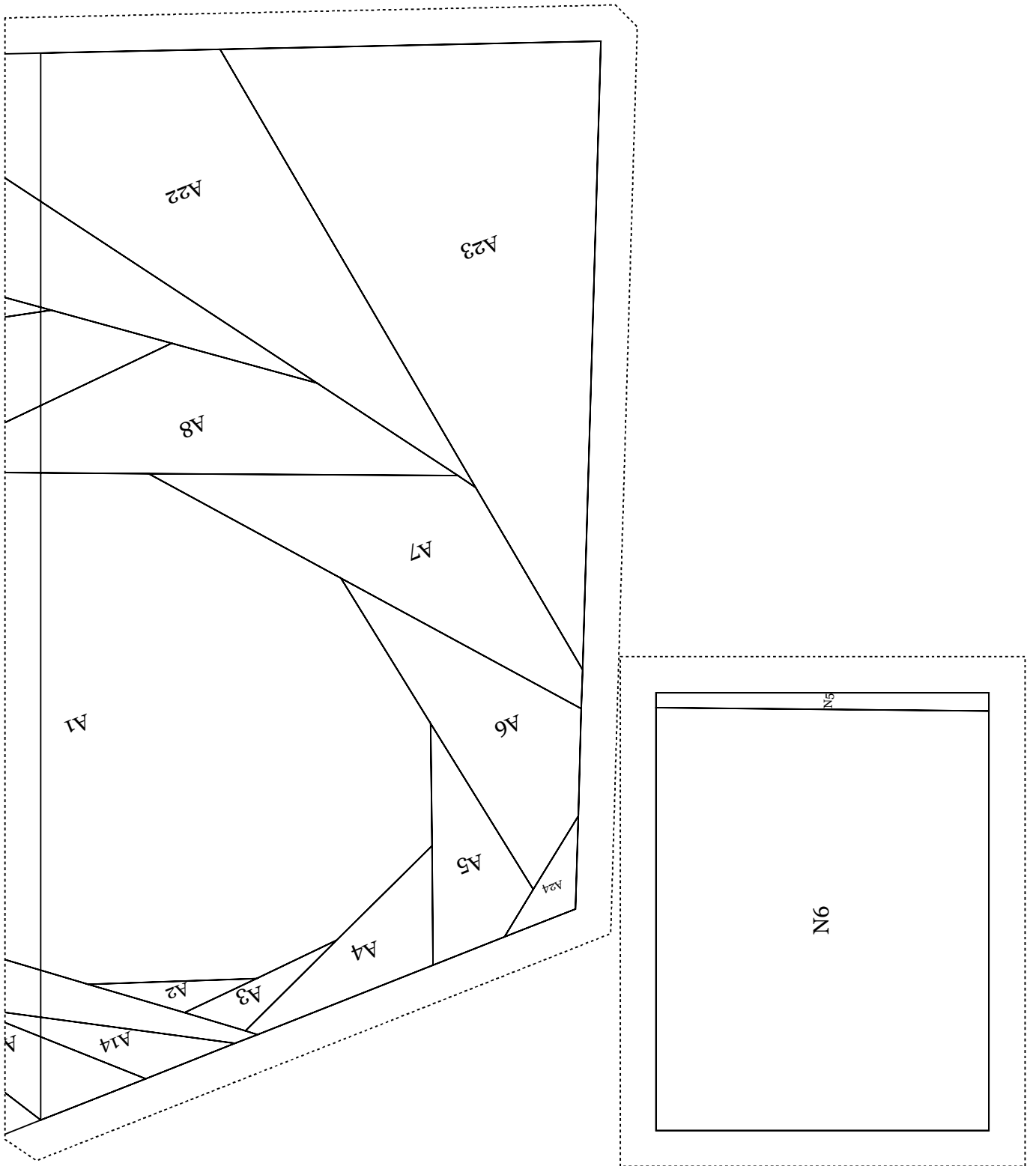

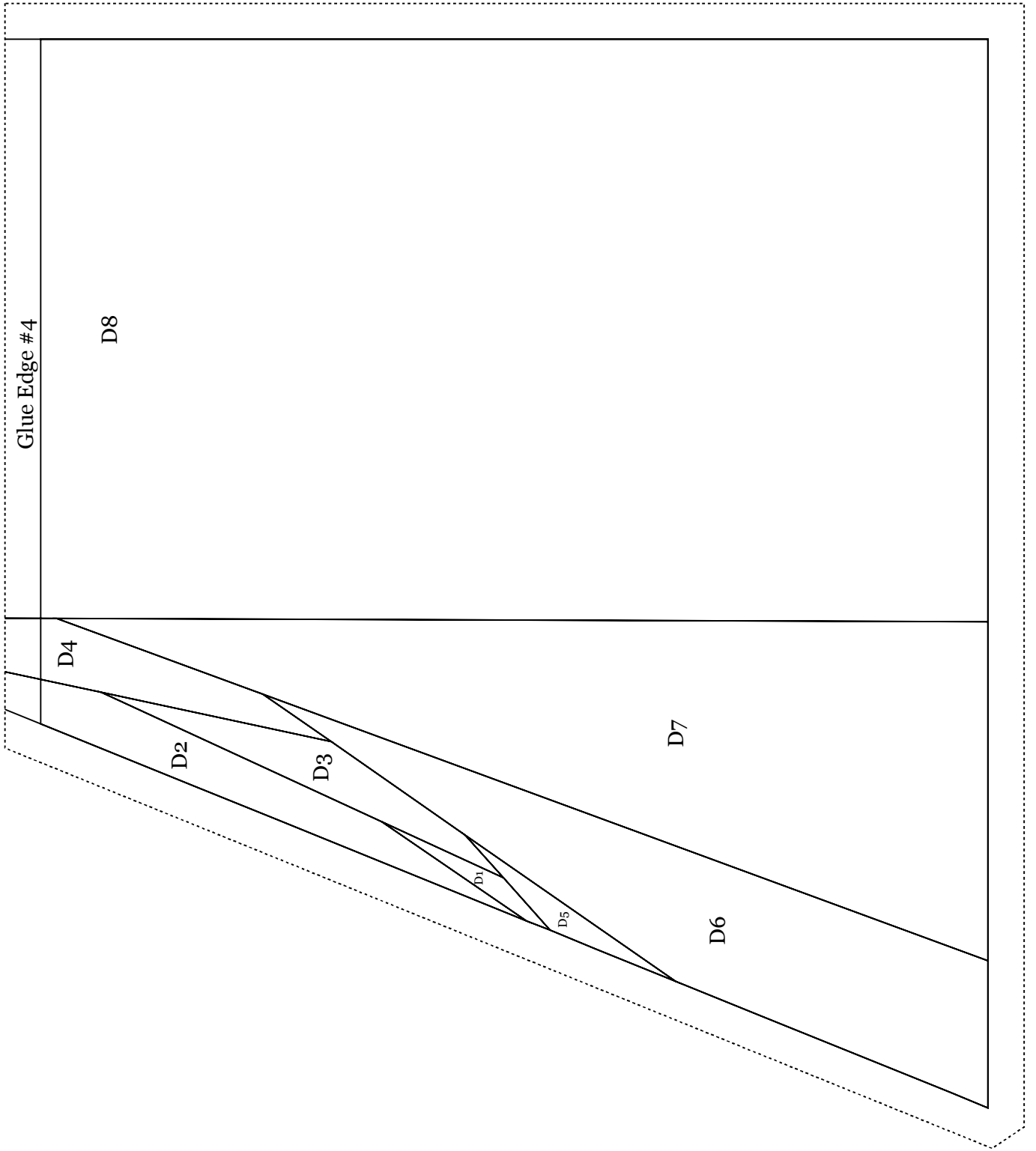

Glue Edge #1

$O_1 [1]$

Glue Edge #1

[1] 10

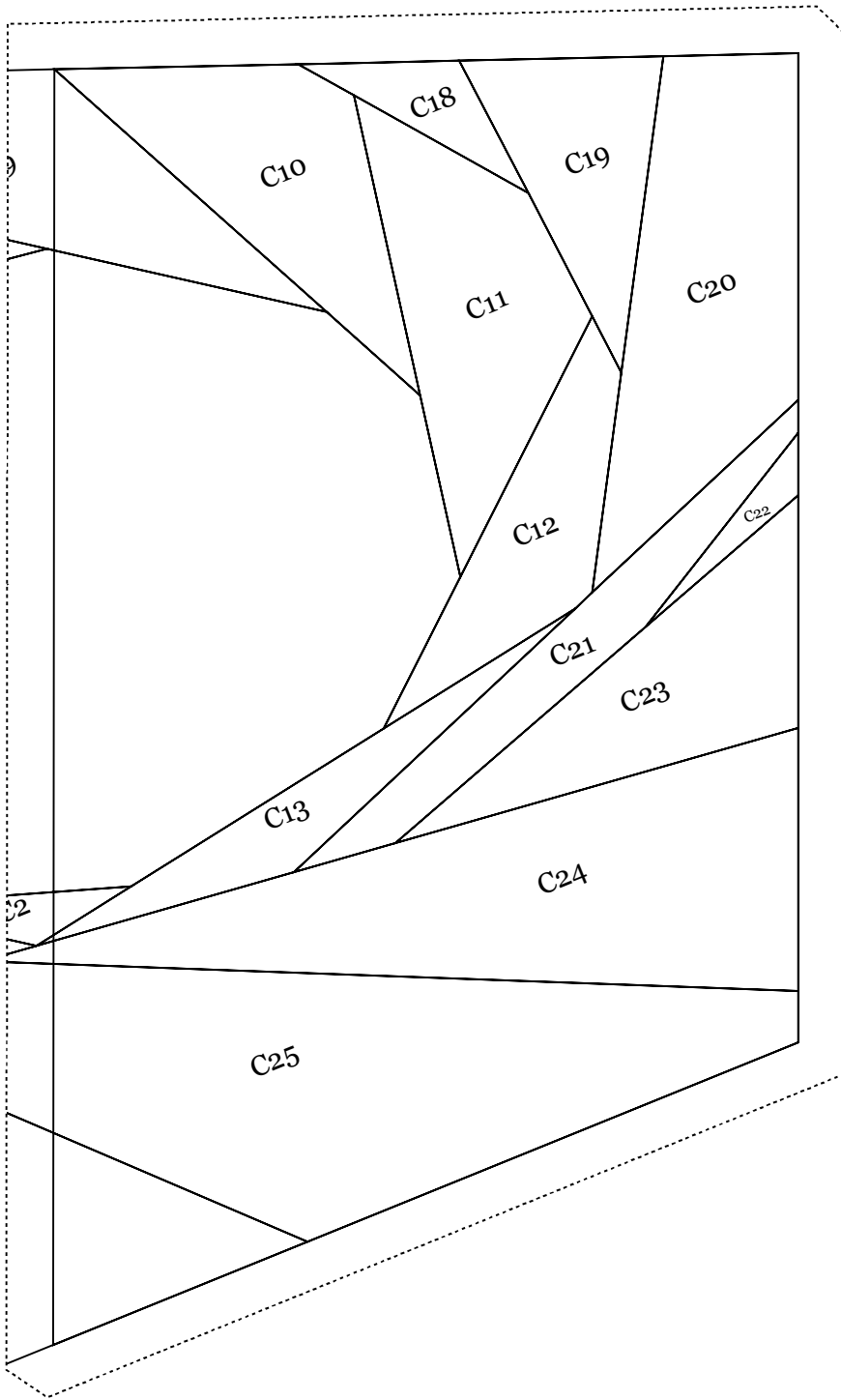

P1 [1]

